



Screeners





Table of Contents

1 Warranty and Assistance	1
2 Important Safety Instructions	2
Printer Power Supply Precautions	3
Printer Rechargeable Battery Precautions	3
3 Quick Start	4
4 Purpose	5
Definition of OAEs	5
Measurement of OAEs	5
5 Description	6
What is the ERO•SCAN Instrument?	6
How are Results Stored and Reported?	6
6 Setup	7
Unpacking the Instrument	7
Optional Accessories	7
Battery Installation	7
Connection to the Printer	8
Loading Paper into the Printer	9
Attaching the Eartips	9
7 Operating Instructions	10
Preparing the Patient for Testing	10
Control Buttons	10
Turning On the Instrument	10
Testing in the Default Modes	11
Testing Children with PE Tubes	12
Test Technique	13
Remote Probe	14
Noise Sources	15
Printing the Test Results	15
Setting the Clock (Time/Date)	16
8 Changing Instrument Settings	17
To Access Menus	17
Test Mode	17
Clearing Test Results	17
Auto-Shutdown Time	17
Headphone Level	18
Save Mode/Storing Test Results	18
Minimum Amplitude	18
Clock Mode	19
Language	19
Reset to Default	19
9 Interpreting Test Results	20
Understanding the Display	20
Understanding the DPOAE Printed Results	20
Understanding the TEOAE Printed Results	21
A Note About Rounding of Results	21
10 Cleaning and Maintenance	22
Cleaning the Instrument	22
Maintenance	22
Probe Tip Replacement	22
Probe Tip Replacement: Remote Probe	22
11 Troubleshooting	23
Problems & Solutions	23
12 Replacement Parts	24



Operating Instructions

ERO•SCAN
OAE TEST SYSTEM

Appendix A: System Specifications	25
Appendix B: Program Flowchart	28
Appendix C: Test Sequence	30
Appendix D: Pass/Refer Criteria	31
Appendix E: Preset Test Protocols	33
Appendix F: Testing at 4 kHz	34



Operating Instructions

ERO•SCAN
OAE TEST SYSTEM

This manual applies to firmware version 7.65.01 and higher.

1 Warranty

Maico Diagnostics warrants that this product is free from defects in material and workmanship and, when properly used, will perform in accordance with applicable specifications. If this instrument does not meet these criteria within one year of original shipment, it will be repaired, or at our option, replaced at no charge when returned to our service facility. Changes in the product not approved by Maico Diagnostics shall void this warranty. Maico Diagnostics shall not be liable for any indirect, special or consequential damages, even if notice has been given of the possibility of such damages.

THIS WARRANTY IS IN LIEU OF ALL OTHER WARRANTIES, EXPRESSED OR IMPLIED, INCLUDING, BUT NOT LIMITED TO, ANY IMPLIED WARRANTY OF MERCHANTABILITY OR FITNESS FOR A PARTICULAR PURPOSE.

For assistance with this ERO•SCAN™ Otoacoustic Emission Test System contact your Special Equipment Distributor or contact Maico Diagnostics by phone at (888) 941-4201 or by fax at (952) 903-4100.

The serial number of your instrument can be found inside the battery compartment and the printer serial number is under the rechargeable battery. Please write the instrument and printer serial numbers below for future reference.

ERO•SCAN Instrument Serial Number: _____

Printer Serial Number: _____

Date Purchased: _____

Purchased From: _____

SAVE THIS MANUAL FOR FUTURE REFERENCE

Manufactured for:
Maico Diagnostics
7625 Golden Triangle Drive
Eden Prairie, MN 55344
(888) 941-4201
(952) 903-4100 Fax

© 2003 ETYMOTIC RESEARCH, INC.
U.S. PATENT #5,954,669; 6,056,698; 6,299,584; 6,331,164
OTHER PATENTS PENDING

Licensed under Otodynamics Ltd. U.S. Patent #4,374,526 and International Patents
Licensed under Madsen Electronics U.S. Patent #5,738,633 and International Patents
Printed in USA



2 Important Safety Instructions

The ER-34 ERO•SCAN™ Otoacoustic Emission Test System should be used only by those individuals trained to perform the testing for which it has been designed. No person should attempt to use this instrument without the necessary knowledge and training to understand how this equipment is to be properly utilized and interpreted.

The ERO•SCAN Instrument probe tip must not be inserted into an ear at any time without a disposable eartip properly affixed.

Precautions

- READ THIS ENTIRE MANUAL BEFORE ATTEMPTING TO USE THIS SYSTEM.
- Use this device only as described in this manual.
- Use only the disposable eartips designed for use with this instrument.
- Never insert the probe tip into the ear canal without affixing an eartip.
- The eartips are disposable and for single patient use only. Do not clean or reuse eartips.
- Use only disposable 1.5v AA/UM-3/R6 Alkaline batteries for the test instrument. Do not use rechargeable cells in this device; do not mix battery types and do not mix old and new batteries.
- Remove the batteries from the instrument if it will not be used for 4 weeks or more.
- Do not immerse the unit in any fluids. See the Cleaning section of this manual for proper cleaning procedures.
- Do not drop or otherwise cause undue impact to this device. If the instrument is dropped or otherwise damaged, return it to the manufacturer for repair and/or calibration. Do not use the instrument if any damage is suspected.
- Use and store the instrument indoors only. Do not use this instrument or its accessories in temperatures below 40°F (4°C) or above 100°F (38°C), or in relative humidity of more than 90%.
- Do not attempt to open or service the instrument. Return the instrument to the manufacturer for all service. Opening the instrument case will void the warranty.
- Do not operate the printer if the power supply has a damaged cord or plug. See the instructions on the following page.
- Do not expose the printed results to sunlight or heat. Printing on thermal paper fades with exposure to light or heat.
- Photocopies of test results should be made if the records are to be kept indefinitely.

**Disclaimer**

The ERO•SCAN™ OAE Test Instrument is designed to be a screening device for hearing loss. Sensitivity and specificity of this type of device are based on the test characteristics defined by the user, and may vary depending on environmental and operating conditions. The presence of otoacoustic emissions suggests normal outer hair cell function, which in turn correlates to normal hearing. However, a passing result using this instrument is not an indication that the full auditory system is normal. Thus, a PASS result should not be allowed to override other indications that hearing is not normal. A full audiologic evaluation should be administered if concerns about hearing sensitivity persist. A REFER test result should not be assumed to be an indicator of a lack of auditory function, however, it should be followed with full audiologic diagnostic testing.

NOTICE: Under certain circumstances, especially in low-humidity environments, common electrostatic discharge may cause this instrument to turn itself off. This effect causes no permanent damage, and the instrument may be turned on again by the normal procedure of holding the DOWN button.

READ THIS SECTION CAREFULLY BEFORE USE**Printer AC Power Source Precautions**

- The printer AC power source converts main voltage (120V AC or 220V AC) to a low voltage (7V DC) for powering the printer. Use only the power source supplied for this purpose.
- This product is for indoor use only. Do not expose to water or excessive dust.
- This product is not suitable for operation in the presence of flammable anesthetic mixture with air or with nitrous oxide.
- Do not cover the power source body as it may result in excessive heating. The power source operates when the plug is inserted into an outlet. To turn it off, remove the plug from the outlet. The outlet must be easily accessible and located near the printer. Should a faulty condition occur, remove the plug from the outlet immediately.

Cleaning and Disinfecting the Unit

Wipe the surface with a cloth slightly dampened with mild detergent or normal hospital bactericides. Do not immerse the unit. Do not clean the unit with isopropyl alcohol or other solvents.





Optional Printer Rechargeable Battery Precautions

- Do not attempt to open the battery pack. The printer battery pack contains Nickel-Cadmium cells. Cadmium is a potentially toxic heavy metal, and exposing the cells increases the risk of leakage or short-circuiting.
- Do not short circuit the battery contacts. This could cause burns or a fire.
- Disconnect the printer power supply before removing or replacing the battery pack.
- Observe local regulations for handling, transport, and disposal of Nickel-Cadmium cells. Regulations in many areas prohibit the disposal of Nickel-Cadmium cells. Complete battery packs may be returned to the manufacturer for recycling.
- The battery pack must be charged for a minimum of five hours before using the printer for the first time. Failure to fully charge the battery pack before use may reduce the life of the battery pack.

3 Quick Start

These steps will allow you to quickly start using the ERO•SCAN OAE Test System. Be sure to perform the necessary otoscopic examination prior to testing. Read the entire manual before testing patients.

NOTE: In order to print the test results, the printer must be charged for 5 hours.

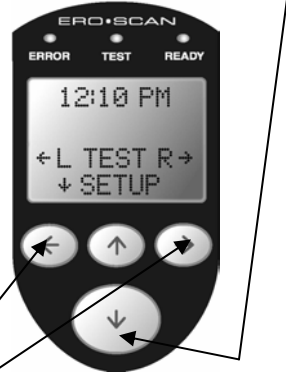
<p>Step 1 Insert 4 AA/UM-3/R6 Alkaline batteries into the hand-held ERO•SCAN instrument.</p> 	<p>Step 5 Insert the eartip deeply into the patient's ear canal to obtain a seal. When a seal is obtained, the ERO•SCAN instrument will automatically begin the test first calibrating and then testing emissions. The red ERROR LED will illuminate if there is noise in the environment. This flashing is normal and will often occur. Once the testing is finished, the unit will Display "PASS" or "REFER" on the LCD Display.</p> 
<p>Step 2 Place an eartip as far down as possible on the probe tip.</p> 	<p>Step 6 When testing is completed on both ears, turn the printer on by pressing the green button on top and place the hand-held unit on the cradle.</p> <p>The most recent test results for both ears will automatically print out.</p> 
<p>Step 3 Turn on the ERO•SCAN instrument by pressing the large DOWN arrow button.</p>  <p>Step 4 Select the test ear by pressing the LEFT or RIGHT arrow key.</p>	



4 Purpose

The purpose of the ERO•SCAN test system is to provide a rapid measurement and documentation of Distortion Product Otoacoustic Emissions (DPOAEs) or Transient Evoked Otoacoustic Emissions (TEOAEs) at several frequencies.

What Are DPOAEs?

Distortion Product Otoacoustic Emissions (DPOAEs) are acoustic signals that can be detected in the ear canal of a person with normal outer hair cell function, subsequent to stimulation of the auditory system with a pair of pure tones at frequencies f_1 and f_2 . The resulting emission of interest is the distortion product tone at the frequency $2f_1-f_2$.

What Are TEOAEs?

Transient Evoked Otoacoustic Emissions (TEOAEs) are acoustic signals that can be detected in the ear canal of a person with normal outer hair cell function, subsequent to stimulation of the auditory system with a series of wideband clicks.

What Do Otoacoustic Emissions Results Tell Us?

Available evidence suggests that otoacoustic emissions (OAEs) are generated by the cochlea's outer hair cells, and that the presence of OAEs is an indication that the outer hair cells are normal. Although OAE test data provide no indication of inner hair cell function, or of hearing ability, current research indicates that the majority of hearing-impaired individuals will be identified by a simple OAE test. Patients who fail to generate OAEs should be rescreened and/or referred for additional audiological testing.

How Does the ERO•SCAN Device Measure DPOAEs?

The ERO•SCAN instrument generates a series of test tones, directs them into the ear canal, and then measures the level of the DPOAE tone generated by the cochlea. By using different test frequencies, the ERO•SCAN device provides an estimate of outer hair cell function over a wide range of frequencies.

How Does the ERO•SCAN Device Measure TEOAEs?

The ERO•SCAN instrument generates a series of clicks, directs them into the ear canal, and then analyzes the spectrum of the returning signal, separating the noise and emission. By using bandpass filters, the ERO•SCAN device provides an estimate of outer hair cell function over a wide range of frequencies.

How Does the ERO•SCAN Device Work?

The digital signal processor in the instrument generates two pure tones (f_1 and f_2) for DPOAEs or a series of wideband clicks for TEOAEs through a digital-to-analog converter. These tones or clicks are presented to the ear via speaker tubes located in the probe. A microphone in the probe measures the sound in the ear canal and transmits the signal to the analog-to-digital converter. The digital signal processor then uses Fast-Fourier Transforms (FFTs) to filter the signal into narrow frequency bands, and detects any emissions present. The level of these emissions can be compared with the level of the noise.

The SPL and frequencies of the test tones and the averaging time used to process the signals can be determined by the tester through adjustable settings maintained in static memory within the ERO•SCAN instrument.

What Frequency Range of Hearing is Estimated?

DPOAEs: Approximately 1 kHz to 12 kHz (depending on the frequency range selected). Since the health of the hair cells in the region of the f_2 test frequency are estimated, and a) the $2f_1-f_2$ emission frequency is at about six-tenths of the f_2 frequency, b) emissions tend to be weak below 600 Hz or so, and c) the ambient noise tends to be highest at low frequencies, the lowest f_2 test frequency that can be routinely measured is about 1 kHz. TEOAEs: Roughly 500 Hz to 4 kHz. TEOAEs can be reliably recorded at lower frequencies than DPOAEs, but cannot be measured reliably above 4 kHz.

5 Description

What is the ERO•SCAN Instrument?

The ERO•SCAN Otoacoustic Emission test instrument is a hand-held device designed to provide an objective measure of outer hair cell function through the measurement of cochlear emissions. It consists of the handheld unit, printer, single-use eartips and other accessories. The name ERO•SCAN stands for Etymotic Research Otoacoustic Emissions Scanner. The ERO•SCAN instrument may be used as a screening tool, or in conjunction with conventional tests as part of a full audiological evaluation.

The ERO•SCAN instrument contains the hardware and software for generating the test stimuli, measuring and displaying the OAEs, and storing the results until they are printed. The plastic housing contains circuit boards that provide the signal processing and display the test results. The instrument also contains 4 AA/UM-3/R6 alkaline batteries to power the device. The instrument uses a liquid-crystal display (LCD) and three light-emitting diodes (LEDs) to provide a visual display of test data and test conditions to the operator.

The probe section of the instrument houses a microphone and two speaker tubes which produce test stimuli and measure the sound pressure level (SPL) present in the sealed ear canal. Interface of the instrument to the ear canal is accomplished through disposable eartips made of industrial elastomer, which fit onto the probe tip.

The disposable eartips are color coded to facilitate easy selection by size. Four membrane-type push buttons located on the keypad of the device allow the user to control testing and printing, and to reset test protocols. Printing will commence upon placement of the instrument into the cradle.

How are the Results Stored and Reported?

When the ERO•SCAN is set in its default settings, the instrument will store the results from one patient (left and right ear) in its non-volatile memory for subsequent printing. However, the ERO•SCAN instrument can store up to 50 test results. The results are displayed via the LCD on the front of the device and are stored in the device's internal memory. After testing is completed, results can be printed using the printer and/or exported to a computer. Test results are stored in the non-volatile memory so the operator can delay printing until a later time if desired.

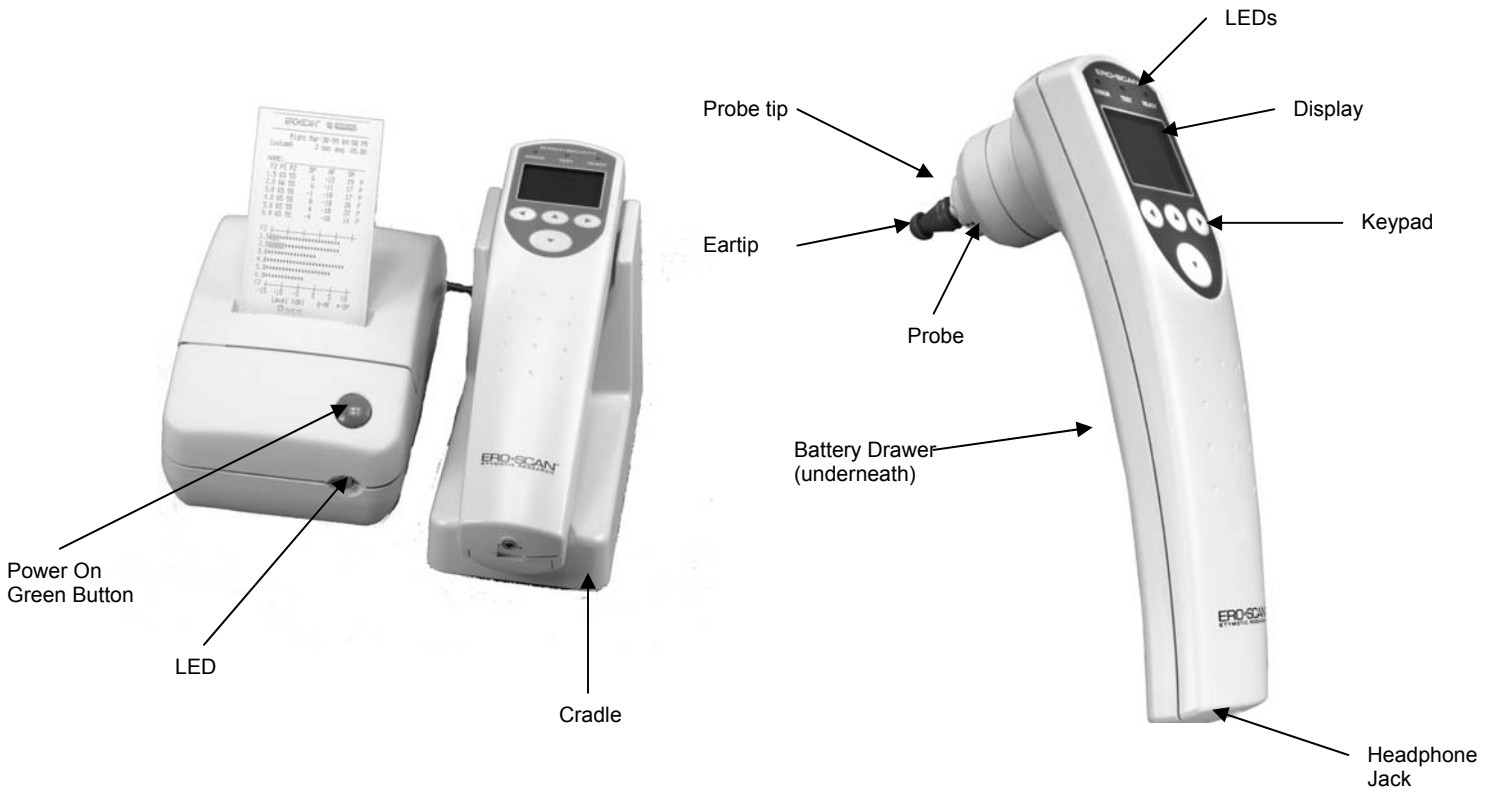

6 Setup

Unpacking the System

The following is a list of parts shipped with each ERO•SCAN system:

- | | |
|-----------------------------|-----------------------------------|
| (1) ERO•SCAN Hand-held Unit | (1) Headphones |
| (1) Cradle | (1) Box of 146 Eartips (12 sizes) |
| (1) Printer | (4) AA/UM-3/R6 Alkaline Batteries |
| (1) Printer AC Power Supply | (1) Thermal Printer Paper Roll |
| (1) Printer Cable | (4) Probe Tips |
| (1) Remote Probe | |

If any of these parts are missing, contact your special equipment distributor or Maico Diagnostics at (888) 941-4201. We recommend that you save the box and packing materials in case you need to store or ship the system.



Optional accessories for the ERO•SCAN include a remote probe, rechargeable battery for the printer, protective carrying case, and database software. The software is Windows compatible and can be used as a stand-alone database or in conjunction with OZ/SIMS and Hi*TRACK™ software.

Battery Installation

The ERO•SCAN instrument uses 4 AA/UM-3/R6 Alkaline batteries. Open the battery compartment by sliding the battery panel down and install the batteries as indicated on the battery label. Once the batteries are correctly in place, slide the panel back onto its tracks to close the battery compartment.

Connection to the Printer

The power pack should be installed into the space provided on the underside of the printer as shown in Figure 1.

Next, use the included connection cable to connect the cradle to the printer as shown in Figure 2. First, insert the 9 pin (broad, flat) connector into the port located on the underside of the cradle. After firmly pushing the 9 pin connector into place, turn the screws on either side to tighten it. Second, plug the mini-din (small, round) connector into the inlet at the rear of the printer. The flat side of the connector (designated by arrows) is oriented toward the bottom of the printer. The cover of the connector will slide back to ease installation of the connector.

Finally, return the cradle and printer to right side up and connect the appropriate ends of the power cord into the power adapter and an outlet.

To turn the printer on, press the green button on the front of the printer. The printer indicator light will flash green to indicate it is ready to receive data from the ERO-SCAN unit. The printer will automatically power off after one minute of inactivity.



Figure 1



Figure 2

Loading Paper into the Printer

Open the cover of the printer by pulling up and back. Orient the paper roll so that the paper will feed from the bottom of the roll (see Figures 4 and 5). Place the roll of paper into the printer by holding the white paper-holder lever back against the case. Allow the lever to slide back so that it fits onto the hub on the paper roll. The paper roll should move freely on the hub. Pull the green paper-roller release lever forward until it snaps in place to disengage the roller. Slide the end of the paper under the roller; it will come out from the front of the roller. Pull the paper end through the roller until it extends about 3 inches above the roller. Push the paper-release lever back. Push the green button on the top of the printer to advance the paper. The printer indicator light on the front of the printer will now flash green if the paper was properly installed. Pressing the green button twice rapidly will print a test run.

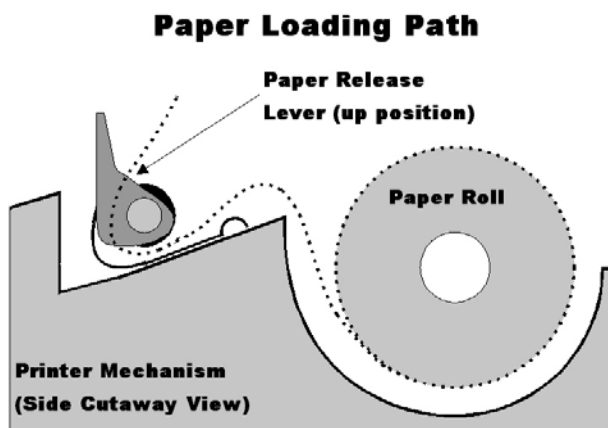

Figure 4

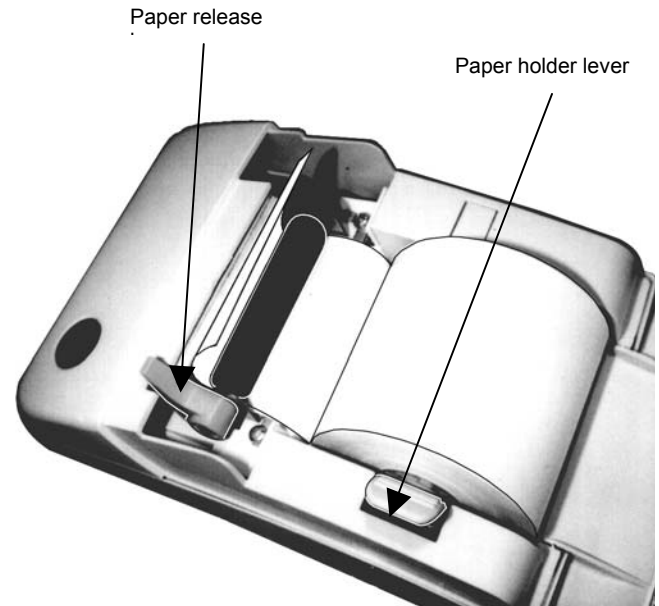

Figure 5

Attaching Eartips

The ERO•SCAN instrument comes with a box of disposable eartips that fit a variety of ear canal sizes. The probe tip must have an eartip attached before inserting it into an ear canal. The eartip kit has 12 different size eartips that are color-coded for easy selection. The determination of the appropriate eartip size should be made by persons with proper training and experience. The eartip must seal the ear canal. The best test results are obtained when the eartip is inserted deeply into the ear canal instead of flush with the ear canal opening. Caution must be taken, however, to ensure that the eartip does not extend too deeply into the ear canal. Use only the eartips approved for use with the instrument. Ordering information can be found on page 24 or inside the eartip box. The eartips are disposable and should be replaced after each patient. Do not attempt to clean or reuse these eartips.

After selecting an eartip, push it onto the probe tip until it is flush against the base of the probe tip. The sound outlet tubes on the probe tip are recessed to minimize the likelihood of clogging. If the probe tip does become plugged or clogged, it must be replaced. See the section *Probe Tip Replacement* on page 22 for further information. To remove the eartip, grasp the eartip at the base and twist it while pulling it straight off the end of the probe tip.



7 Operating Instructions

Preparing the Patient for Testing

Otoscopic examination of the patient's ear canals should be performed prior to testing. Excessive cerumen or vernix in the ear canals may interfere with the test and give invalid or incomplete results. Patients with excessive cerumen, debris, or foreign bodies in the ear canals should be referred to an audiologist or physician for removal of the blockage prior to testing.

Place the patient in a position that will allow the ERO•SCAN instrument to be held steady while testing is in progress. The patient should remain still and quiet while the test is being performed.

Control Buttons

The ERO•SCAN instrument uses 4 buttons to control all functions of the instrument. These buttons are arranged in a directional cursor format. The arrows on the keys (← LEFT, → RIGHT, ↑ UP, ↓ DOWN) correspond to the arrows that are used on the screen. The screen will indicate which button to push by showing the appropriate arrow.

NOTE: The UP key will always bring the instrument back to either the previous menu or the main menu. The UP key will also turn the unit off when the instrument is at the Main Menu.

Turning On the Instrument

To turn on the ERO•SCAN instrument, press the large DOWN key located below the instrument's display screen. Three small lights (red, yellow and green) will appear briefly just above the display screen. The green ready light will remain on. Display #1 shown below will quickly appear. This display will indicate the type of instrument (screener), software version, serial number, and operating mode.

If the batteries have sufficient power, the ERO•SCAN instrument will automatically check the date and time settings. If there are no date/time errors detected, the Main Menu (display #2) will appear on the display.

NOTE: If this is the first time the ERO SCAN instrument is being used, or if you wish to change the date or time, see *Setting the Clock* on page 16 for instructions on setting the correct date and time.



Display #1

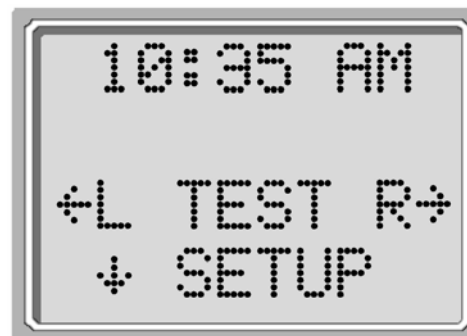

Display #2 – Main Menu

Automatic Shutdown

The ERO•SCAN instrument has an automatic "shutdown" feature, designed to prolong battery life. The unit will automatically shut down after 1 minute (default) of inactivity. To turn it back on, simply press the large DOWN key. This feature can be re-programmed for various periods of inactivity before "shut-down." (See the *Changing Instrument Settings – Auto-Shutdown Time* section on page 17 for further information on this feature.)



Testing in the Default Modes for Both DPOAE and TEOAE

For either DPOAEs or TEOAEs there are a default test protocol.

The settings for testing in the default DP protocol are as follows:

Number of Frequencies Tested = 4
Frequency Range = 2 kHz to 5 kHz
P1 (Intensity of F1 in dB SPL) = 65
P2 (Intensity of F2 in dB SPL) = 55

Averaging Time = 4 Seconds
Pass SNR (Signal-to-Noise Ratio) = 6 dB
Number of Passing Frequencies for Overall Test "Pass" = 3

The settings for testing in the default TE protocol are as follows:

Number of Bands Reported = 6
Frequency Range = 1.5 kHz to 4 kHz
Click Presentation Level = 83 dB
SPL Peak Equivalent

Averaging Time = 64 Seconds
Pass SNR (Signal-to-Noise Ratio) = 4 dB
Number of Passing Frequencies for Overall Test "Pass" = 3

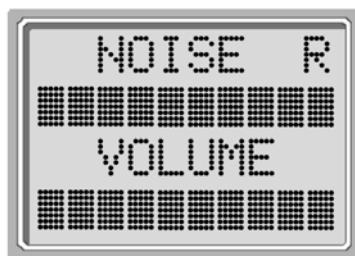

Display #3

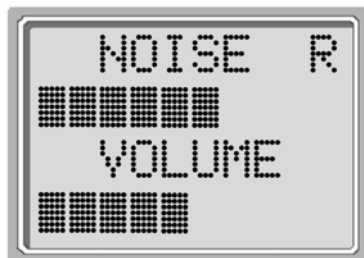

Display #4

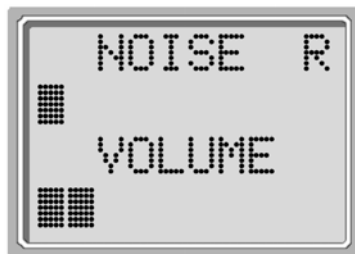

Display #5

To Begin Testing

To begin testing, place an eartip as far down as possible on the probe tip, turn on the ERO•SCAN instrument by pressing the down button and select either the LEFT or RIGHT arrow key to indicate which ear will be tested. After the test ear is selected, display #3 will be shown. This display shows two horizontal bar graphs representing the environmental noise (NOISE) and the ear canal volume (VOLUME).

When both bars fill the screen from left to right, the environmental noise is high and the ear canal volume is large. As the unit is inserted into the ear canal, both horizontal bars should decrease from right to left indicating a decrease in environmental noise and ear canal volume. To obtain a seal and measure emissions, gently insert the eartip into the patient's ear canal. It should fit snugly and comfortably.

The best test results are obtained when an eartip is inserted deeply into the ear canal instead of flush with the ear canal opening (See Appendix F). The NOISE and VOLUME bar readings should be used as an indication that the unit is sealing the ear canal. If the VOLUME and NOISE bars continue to fill the screen, the unit is not sealing the ear canal, and appropriate adjustments should be made until a decrease in these bars is seen.

Note that for an adult, the VOLUME bar will decrease to about half (display #4), while for a newborn or child, the VOLUME bar will decrease further to the left (display #5). The NOISE bar will show a decrease from the original reading. When a seal is obtained, the unit will automatically begin testing (autostart) and the yellow test LED will illuminate throughout the test.

When testing DPOAEs, the default test time is 16 seconds. When testing TEOAEs, the default test time is 64 seconds, however, the test will automatically stop when the pass criteria has been met or exceeded. The arrow key can be used to abort a TEOAE test in progress.

To test children with PE tubes, the autostart needs to be disabled. This is accomplished by first inserting the ERO•SCAN with appropriate ear tip into the ear canal and obtaining a proper seal. To disable autostart at the main menu select the ear to be tested by holding down the RIGHT or LEFT arrow keys for 3 seconds until the green "test" light turns off. Once the key is released, the ERO•SCAN will calibrate and test as before.



Display #6

Auto Calibration

The ERO•SCAN instrument will automatically perform a calibration at the start of each test and display #6 will briefly be shown on the LCD. During calibration a series of tones will be presented to the ear canal to calibrate the levels of the frequencies to be tested. It is very important that the ERO•SCAN unit be held steady in the patient's ear canal while the yellow test LED is illuminated.

Following the automatic calibration of the test tones, a set of bars should appear on the display (display #7). These are the test results which are displayed as the emissions are measured. Two bars are used to represent the signal-to-noise ratio measured at each of the test frequencies (DPOAEs) or in each of the frequency bands (TEOAEs).

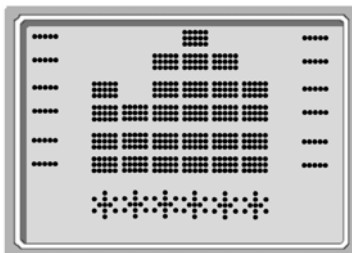

Display #7

Testing is complete when the green "READY" light is illuminated. Both the tester and patient should remain as still and quiet as possible until the green light turns on. The graphic display is explained in the *Interpreting Test Results* section on page 20 and 21.

Reviewing Results

When testing is complete, a display similar to display #8 will appear. The results of the test are automatically saved in memory as soon as the test is complete. The results will be saved even if the unit turns off or the batteries are temporarily removed. This screen again indicates the test ear and further gives the results of the test. "PASS" on the screen indicates the patient passed the screening, "REFER" indicates that the patient did not pass the screening. "NOISY" indicates that excessive noise was present during the test. "NO SEAL" indicates that a seal was not maintained throughout the test. "FIT ERR" indicates inadequate probe placement in the ear canal to produce target stimulus intensities. When the test result is "Noisy", "No Seal", or "FIT ERR" the tester should reposition the probe, selecting a different size eartip if necessary, and retest. If the test result is "REFER" the tester can determine from the printout whether the test should be repeated. To review the results, push the DOWN arrow key to return to the bar graphs.

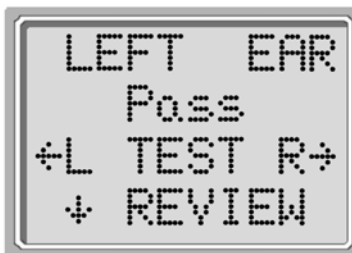

Display #8

After reviewing the results, again push the DOWN arrow key to return to the Main Menu. Once a new test for that ear is started, the previous results are erased. **By default, the ERO•SCAN instrument will save only the last test for each ear. When testing is completed, the results should be printed before a new patient is tested.** Note, however, that the ERO•SCAN instrument can be configured to store up to 50 tests in the unit for printing at a later time. It is important to keep a record of the test number for each patient if this feature is used. See *Save Mode/Storing Test Results* on page 18 to set up the device to save 50 tests in memory.



Test Technique

As with other otoacoustic emission test instruments, there is a technique to learn when using the ERO•SCAN instrument, especially for newborns and infants. Experience with existing OAE systems suggests that it may take up to 3 months to become completely proficient at screening newborns. When testing a newborn or infant with the ERO•SCAN instrument, the following suggestions might be helpful: The newborn has to be relatively quiet and calm; it is usually preferred for the infant to be asleep. A pacifier may be used to calm the newborn, however, sucking will add noise to the test and decrease the likelihood of a passing result.

When testing a newborn, gently pull down and back on the pinna to straighten out the ear canal. Prepare the ERO•SCAN unit by turning on the device, selecting the test ear and eartip. **It is very important to select the eartip and push the arrow key which selects the test ear before placing the ERO•SCAN instrument into the newborn's ear canal. Pushing the button after the eartip is in the ear canal may startle the baby and will cause a noisy test result.** Gently place the probe tip into the infant's ear canal using a cone-shaped or small (green or yellow) mushroom-shaped eartip.

The cone-shaped eartips tend to insert deeper down into the ear canal than the mushroom-shaped eartips. This deeper insertion into the ear canal allows for the measurement of larger emissions due to the reduced ear canal volume. Deeper insertion of the probe tip is desirable, however, it may also waken the newborn and cause them to startle. If this happens, the use of the mushroom-shaped eartips is more desirable. The use of a mushroom-shaped eartip is more effective in testing if the eartip enters the ear canal, rather than sitting flush with the ear canal opening. Warming the eartips prior to insertion also helps to keep the baby calm during testing.



Figure 1a

Remote Probe

As an alternative to testing with the internal probe of the ERO•SCAN instrument, a remote probe can be purchased as an option. This probe may be preferred by some users for the testing of infants and other difficult to test populations such as individuals with multiple handicaps. The probe allows the user to insert the probe tip into the ear and then wait until the patient is quiet before starting the test.

Installing the Remote Probe

1. Remove the protective cover from the top of the ERO•SCAN using a fingernail or small screwdriver (Figure 1a).
2. Turn off the ERO•SCAN and insert the remote probe plug into the socket on the top of the ERO•SCAN (Figure 1b). The plug will fit only in one direction. The arrows on the plug should face the display on the ERO•SCAN.



Figure 1b

Note: Misalignment of the plug and socket when installing the remote probe can cause damage to the pins in the plug and the pin receptacles in the socket. The plug and socket should be visually inspected prior to each installation of the remote probe. If damage is observed, contact your Special Equipment Distributor or Maico Diagnostics.

3. Turn on the ERO•SCAN. The yellow TEST light on the display will light briefly, indicating the ERO•SCAN has detected the presence of the remote probe. Disconnect and reinsert the connector if the yellow light is not seen.

Note: All testing is done through this probe until it is unplugged. ERO•SCAN settings do not need to be changed in order to use this probe.



Figure 2a

Testing with the Remote Probe

1. The remote probe uses the same disposable eartips as the ERO•SCAN probe. Place the eartip fully onto the probe tip (Figure 2a).
2. Never use the probe without an eartip installed. Use the shirt clip on the remote probe box to secure the probe to clothing or bedding.
3. Check the ear canal for cerumen or vernix before inserting the probe.
4. Turn on the ERO•SCAN and select the ear to be tested.*
5. Insert the probe into the ear canal (Figure 2b). Lift gently on the outer ear during insertion to straighten the ear canal and ensure proper placement.
6. The AUTO-START function automatically begins the test when the probe is inserted correctly. If the ERO•SCAN does not start the test, reposition the probe.



Figure 2b

***NOTE:** When testing infants or young children it is recommended that the probe be placed in the ear before selecting the test ear on the ERO•SCAN. When the child is quiet, select the ear to be tested.



Noise Sources

When the noise level exceeds the noise rejection limit of the instrument, the red ERROR light will appear. The ERROR light will usually appear while testing. The light will appear infrequently if the noise level in the ear canal is low, and it will appear more often if the noise level in the ear canal is high. Otoacoustic emissions are very low-level sounds. Any noise in the ear canal at the time of testing can mask this emission. This noise can come from a variety of sources.

The largest source of noise can come from the patient. This is biological noise, such as movement, coughing, sucking, talking, etc. The patient must be calm and not move or talk. Ambient noise in the testing environment can also be a large source of noise during the test. A properly sealed eartip can block a large amount of this noise, but performing the testing in a relatively quiet environment is recommended. Another source of noise is the tester. The ERO•SCAN instrument has an isolation mechanism that will isolate most of the tester's hand movement and associated noise from the probe, but the tester should hold the instrument as steady as possible.

Printing the Results

It is recommended that the results be printed after each patient. The ERO•SCAN instrument will save the most recent test results for each ear and print only these results in the "Default" mode. This allows the user to retest a patient after a "REFER" result and to print out only the most recent test result for each ear. Turn the printer on by pressing the green button before placing the instrument in the cradle. The test results that are stored will print out automatically. The results of the most recent test from each ear will continue to be stored in memory until another test is completed.

NOTE: The ERO•SCAN instrument automatically prints test results stored in memory each time the instrument is placed in the cradle. If the instrument is set to the "L/R" save mode, only the most recent test result for each ear will be printed. If it is set to the "50" save mode the printer will print all tests stored in the ERO•SCAN memory. For ease of recordkeeping, it is recommended that you print test results after each patient.

The ERO•SCAN instrument can be configured to store up to 50 tests in memory before printing. See the section *Changing Instrument Settings - Save Mode/Storing Test Results* on page 17 for instructions to save more than two tests in memory.



Display #9

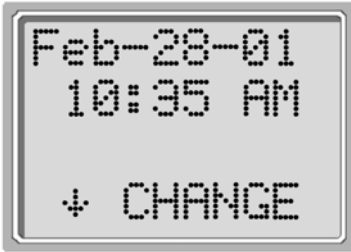

Display #10

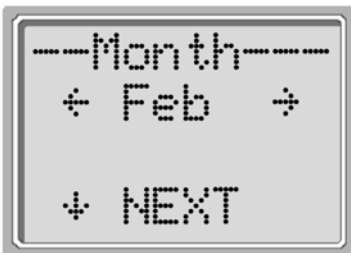

Display #11

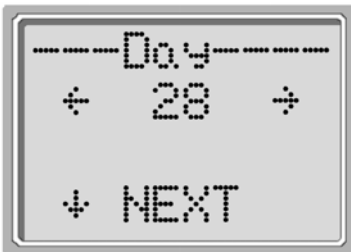

Display #12



Display #13

Setting the Clock

When the ERO•SCAN test instrument is first used, the correct date and time will need to be set on its internal clock. The date and time are listed on the test printout as month-day-year (e.g., Feb-28-01). The clock should be set prior to testing, as changing it after tests are saved will not change the date on the printout (i.e., whatever date was previously in memory will be the date on the printout).

Seasonal time changes such as Daylight Savings Time will also require resetting the clock. If the instrument's batteries go dead and are not replaced within approximately one hour, display #9 as shown on the left may appear. If this message appears, reset the time and date.

To change the time and date press ↓SETUP at the main menu (display #2). display #10 will show the current date and time presently set in the unit. If the time and date are correct, press the UP key to escape back to the main menu. If either the date or time is incorrect, press the ↓CHANGE key to access the menu to change the month (display #11). Press the LEFT or RIGHT keys to scroll forward or backward through the months.

You will see the abbreviated name for each month. When the desired month appears on the display, press the DOWN key to enter the day selection screen (display #12). Pressing the LEFT or RIGHT keys will scroll through the days of the month.

After the correct day is selected, press the DOWN key to enter the year selection (display #11). Pressing the LEFT or RIGHT keys will scroll through the years. When the correct year is selected, press the DOWN arrow key to enter the hour menu (display #14). Again use the LEFT or RIGHT arrow keys to set the correct hour. Press the DOWN arrow key to enter the minute menu (display #15) and use the LEFT or RIGHT arrows to select the correct minute. When the correct minute is selected, pressing the DOWN arrow key will return to the Main Menu.

The time and date changes are automatically saved.



Display #14

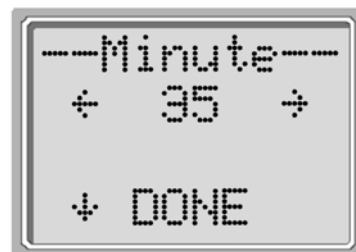

Display #15

8 Changing Instrument Settings

To Access Menus

The ERO•SCAN instrument allows the user to change many of the instrument's settings or functions. These settings include the Test Mode, Clearing Test Results, Auto-Shutdown Time, Headphone Level, Minimum Amplitude Value, Save Mode, Clock Mode, Language, and Reset to Default Settings. To access the menus to change these functions, press the ↓SETUP key from the Main Menu (display #2, page 10) to enter the CHANGE menu (display #10, page 16). At this menu, hold down the ↓CHANGE key for 3 seconds until the Ready light (green LED) turns off. Releasing the ↓key will then access the menus to change the instrument settings.

Test Mode

The Test Mode menu (display #16) allows the user to change the test protocol (DP Screener only). The Test Modes that can be selected include either DP (DPOAE) or DP Custom.

NOTE: DP Custom is a fixed test protocol with a total test time of approximately eight seconds (2-second averaging time at each of four test frequencies). The default DP protocol is a 16 second test (4-second averaging time at each of four test frequencies). The shorter test time of the DP Custom protocol offers an advantage when testing young children or uncooperative subjects who may tend to move considerably during the test. The longer averaging time of the default DP protocol offers an advantage when testing in noisy environments. The tester can select the appropriate test protocol based on the subject being tested and the test environment.

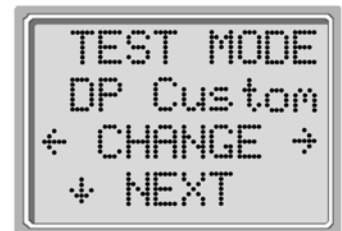

Display #16

Clearing Test Results

The Test Results Clear menu (display #17) allows the user to clear the test results stored in the unit without printing them. Select the LEFT or RIGHT arrow key to clear the results and select Yes or No to verify clearing (or not clearing) the results (display #18).

Auto Shutdown Time

The Power Off menu (display #19) refers to the Auto-Shutdown time which controls how long the ERO•SCAN instrument waits before shutting itself off after a period of inactivity. It is not necessary to manually turn off the ERO•SCAN unit. The Automatic Shutdown feature is designed to prolong the battery life of the instrument when it is not in use. By default, the instrument automatically shuts off after 1 minute has elapsed.

The Auto-Shutdown time may be increased or decreased by pressing the ←CHANGE→ keys. The times available are 30 seconds (0.5 minute), 1, 2, or 4 minutes. Once you have made your selection, press ↓NEXT.

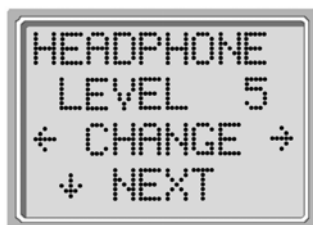

Display #20

Headphone Level

The Headphone Level menu (display #20) is next. Using the headphones provided with the ERO•SCAN instrument enables the examiner to listen to the calibration and test tones (DP Instruments only). The headphone plug should be inserted into the jack at the bottom of the ERO•SCAN instrument. The headphones may be used both as a learning tool and for real-time monitoring of the ear canal during the test.

Press the ←CHANGE→ keys to change the volume level for the headphones. The volume level may be set from 1 - 9 with 1 being the lowest volume level and 9 as the highest volume level. The default value is 5 and should be suitable for most situations.

NOTE: Changing the headphone volume will not change the intensity of the test tones that are presented to the patient.

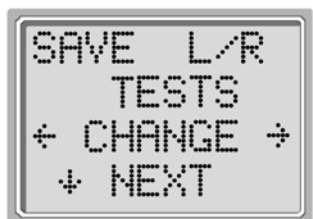

Display #21

Save Mode/Storing Test Results

The Save Mode menu is shown in display #21. The ERO•SCAN unit automatically stores only the most recent test result for each ear (L/R). The unit has the capacity to store 50 individual tests. To change the mode to save up to 50 tests, press the LEFT or RIGHT arrow keys to change the menu to 50. It is recommended that you go to the Test Results Clear screen (described on page 17) to clear any previous memory locations after you first select this option. When the ERO•SCAN unit has a full memory (50 saved tests), it will not allow any further testing. At this point either the results must be printed or they must be cleared from memory. It is important to keep a record of the test number for each patient if this feature is used.

Upon saving test number 45, the red "ERROR" light will come on. At this point, five more tests can be stored. Press ↓CONTINUE to proceed with testing. When 50 tests are saved, select ↓TEST from the Main Menu, the display will ask if you want to clear all 50 results. (NOTE: You may print or download the saved results at this time.) If you choose ↓CLEAR, all 50 tests will be deleted and the test numbers will start again at 1. The ERO•SCAN unit will ask to verify your decision to erase all stored tests. To print, select ↓MAIN MENU, turn on the printer, and set the instrument on its cradle. All stored tests will be printed.

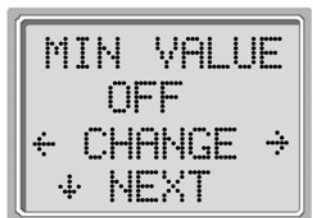

Display #22

Minimum Amplitude

Select the ↓NEXT key to exit this menu. The Minimum Amplitude screen is displayed. This setting allows the user to set the unit to include minimum amplitude values in the pass/refer criterion. If the MIN VALUE is set to "ON", a result is not considered a pass unless the amplitude at each frequency is equal to or greater than the minimum value programmed into the unit. This is in addition to meeting the other pass criteria including the minimum SNR and the number of passing frequencies for overall test "Pass." The ERO•SCAN is set with this feature turned off when it is shipped from the factory.

The minimum DP amplitude is -5 dB SPL.

The minimum TE amplitude is -12 dB SPL.

Clock Mode

Select the ↓NEXT key to enter the Clock Mode (display #23). This menu allows the user to change the clock from a 12 hour mode to a 24 hour mode. To change the clock mode, press the ←CHANGE→ keys. Press the ↓NEXT to exit this menu.



Display #23

Language

The Language setting allows the user to select among several languages. Language options include English, German, Spanish, and French. To change the language, press the ←CHANGE→ keys until the desired language is shown. Press the ↓NEXT to exit this menu.

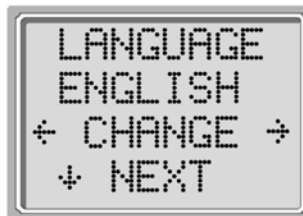

Display #24

Reset to Default

Selecting the LEFT or RIGHT arrow key in the Reset to Default menu (display #25) will return the instrument settings to their original factory settings. (NOTE: This does not affect the custom settings.)

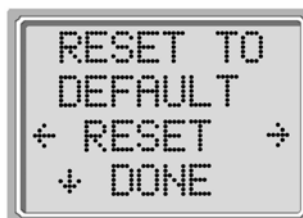

Display #25

9 Interpreting Results

Understanding the Display

The display on the ERO•SCAN test instrument will indicate the results of the test with a graphic display. The display will be generated and shown during the test and can be reviewed after the test is complete. The display might differ depending on the settings used for the test.

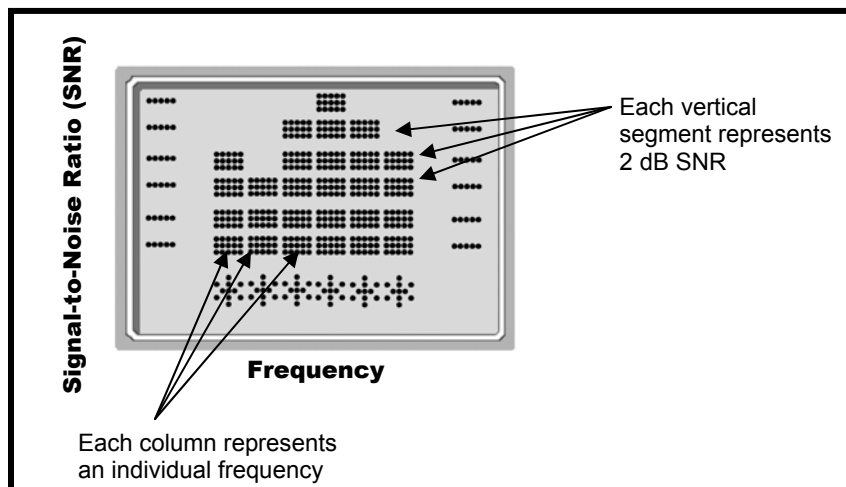

The display shows a 6-column graph. Each frequency (DPOAEs) or frequency band (TEOAEs) is indicated by one column. Either 4 or 6 columns appear depending on how many frequencies are tested. Each row represents 2 dB of signal-to-noise ratio (SNR). For example, if the column goes to the top of the display then the SNR is 12 dB or greater (6 rows of 2 dB each).

The display is shown while the test is being performed. To review the display after the test is finished, press the ↓REVIEW key to look at the display.

Understanding the DPOAE Test Results

Each test will generate its own printout.

1. The test number.
2. The ear selected.
3. The time and date of the test, based on the setting of the internal clock. If the clock is set correctly, this time and date will be correct.
4. The software version number.
5. The averaging time used for this test.
6. The mode selected for this test.
7. The f2 frequency.
8. The pressure levels of f1 and f2 respectively.
9. The level of the emission in dB SPL.
10. The noise floor in dB SPL.
11. The signal-to-noise ratio (DP level minus the noise floor).
12. A "P" indicates that the signal-to-noise ratio for the test was equal to or above the SNR criterion.
13. The thick bars indicate the noise floor in dB SPL.
14. The small bars indicate the emission level in dB SPL.

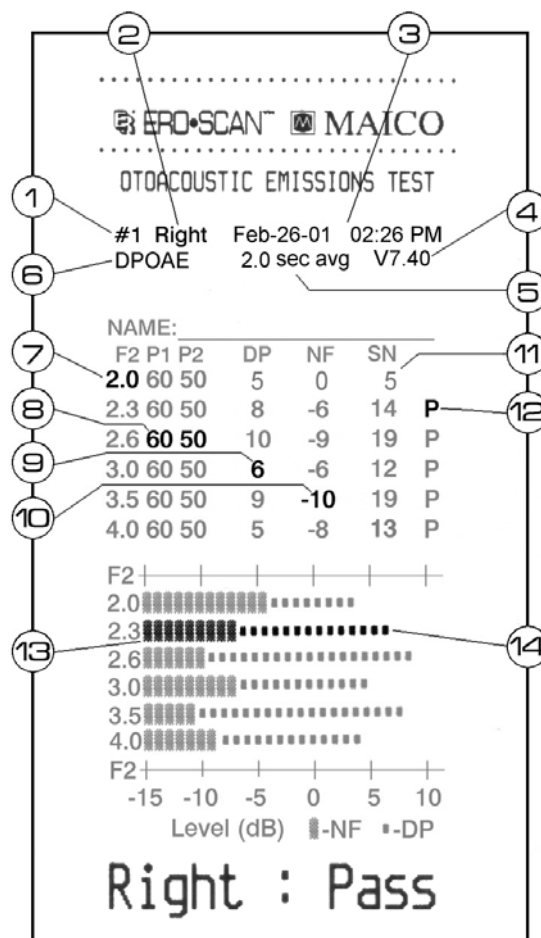

10 Cleaning and Maintenance

Cleaning the Instrument

This instrument and its accessories may be wiped clean with a damp cloth using a mild antiseptic solution (e.g., cetyl chloride). Take care not to put excessive pressure on the clear display window or allow any utensil to puncture the display window or keypad. **Do not allow any fluid to enter the device.** Do not immerse the instrument in fluids or attempt to sterilize the instrument or any of its accessories.

Maintenance

This instrument requires no regular maintenance beyond routine cleaning and battery replacement. The probe tip requires replacement only when it becomes clogged.

Probe Tip Replacement

Probe tips are disposable and should be replaced when they become clogged. Four replacement probe tips are included with this instrument. Do not attempt to clean the probe tip. (See the *Replacement Parts* section on page 24 for ordering information.)

To replace the probe tip, squeeze the tabs as shown in the picture Figure 1. The tabs should audibly snap off the probe assembly. Pull the probe tip directly off the probe and discard it.



Figure 1

Obtain a replacement probe tip and orient the tip as shown in the picture Figure 2. The probe tip will only fit on one way; be careful not to force the tip in place. Push the tip directly down onto the probe. Once the probe tip is in place on the probe, push firmly downward on the top of the tabs one at a time until a click is heard. Tug lightly on the probe tip to verify that the tip is securely attached.



Figure 2

Probe Tip Replacement: Remote Probe

To remove:

1. Using a small pointed object, such as a pen or small screwdriver, push in the notches on the left and right sides of the rear of the remote probe until each tab is released (Figure 3a).
2. Slide the probe tip off the front of the probe and discard (Figure 3b).

To replace:

1. Align a replacement tip with the front of the probe (Figure 3c). **The tip will only fit in one direction.** If the tip does not fit securely on the probe, remove the probe tip and reorient it.
2. Press lightly on the tabs to snap them into place (Figure 3d).

NOTE: If the probe tip is not inserted completely, the ERO•SCAN will not perform a test.

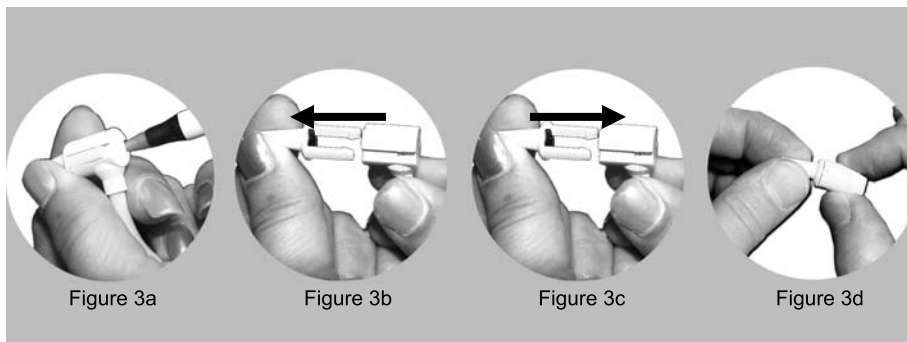

Figure 3a

Figure 3b

Figure 3c

Figure 3d

11 Troubleshooting

1. Problem: Instrument does not turn on.

Solutions:

- The DOWN arrow key must be pressed for a full second.
- Check that the batteries are installed correctly.
- Install new batteries.

2. Problem: The test will not start even though the instrument is in an ear canal.

Solutions:

- Try a different size eartip.
- Verify that the eartip is sealed in the ear canal via feedback from the NOISE and VOLUME bars during AUTO-START.
- Check that the instrument will start when inserted in the calibration cavity.
- Reseat or replace the probe tip.

3. Problem: The printer doesn't print.

Solutions:

- Press the green button on the printer and try again.
- If the printer light doesn't turn on, plug in the printer power supply to charge the battery.
Note: You will have to wait a period of time before printing will occur even when AC power is provided.
- Verify that the printer battery pack is installed correctly.
- If paper comes out of the printer but there is no text on the paper then the paper is in backwards.
Remove the paper and reinstall the paper so that it feeds from the bottom of the roll.
- Check that the printer cable is correctly attached to the cradle and the printer.
- Are there any tests in memory to be printed?

4. Problem: "Printer paper low" message appears on LCD.

Solutions:

- Open printer cover and reposition or replace the paper roll.

12 Replacement Parts

How to Order

Replacement disposable eartips may be ordered from your Special Equipment Distributor or from Maico Diagnostics.



11 mm
Yellow



12 mm
Red



13 mm
Blue



14 mm
Green
(not provided in kit)



16 mm
Yellow
(not provided in kit)



6 mm
Green



7 mm
Yellow



8 mm
Red



9 mm
Blue



10 mm
Green



Infant
Red



3 mm
Yellow



4 mm
Red
(not provided in kit)



5 mm
Blue
(not provided in kit)

Printer Paper can be obtained from most office supply stores. The paper is thermal calculator paper, 2.25" wide, and a maximum of 2.5" diameter.



Thermal Calculator Paper



Probe Tips



Remote Probe Tips

Probe Tips and Remote Probe Tips may be ordered from your Special Instrument Distributor or Maico Diagnostics at (888) 941-4201.



Appendix A

PROBE SPECIFICATIONS

Measurement Type: Distortion Product Otoacoustic Emissions (DPOAE) and/or Transient Evoked Otoacoustic Emissions (TEOAE)

Frequency Range: 2 to 5 kHz (DPOAE) 1.5 to 4 kHz (TEOAE)

DPOAE Stimulus Intensity Range: 66/55 dB SPL

TEOAE Stimulus Intensity Range: 83 dB SPL peak equivalent (± 3 dB)

Maximum Output (protection): 90 dB SPL

Microphone System Noise: -20 dB SPL @ 2 kHz (1 Hz bandwidth) / -13 dB SPL @ 1 kHz (1 Hz bandwidth)

Stimulus Sampling Rate: 31,250 Hz

INSTRUMENT SPECIFICATIONS

Power Supply: (4) AA/UM-3/R6 cells - Alkaline (6 V total)

Battery Life: Approximately 300 tests

Instrument Weight: 10.6 oz. (300 g) including batteries

PRINTER SPECIFICATIONS

Type: Thermal dot matrix line printer

Speed: >10 lines per second

Operating Noise: <50 dB SPL

Weight: 1.4 lbs. (630 g) including battery pack

Power Supply: EN60601-1

Input: 100-240 V~, 50-60 Hz, 1.2A

Output: +7 V, 5.0 A

Paper: Calculator-type thermal roll - 2.25" wide

PROCESSOR SPECIFICATIONS

Digital Signal Processor: Motorola 56303 24-bit 66 MHz 3.3 V

Storage: 2 Mbit Flash EEPROM (non-volatile)

Battery Backup: 0.1F 5.0 V (approx. 24 hours)

CODEC: 18 bit D/A, 18 bit A/D 96 dB SNR typical

Display: 4 line x 10 character STN liquid crystal

Switches: Membrane keypad 1 million + actuation

REMOTE PROBE SPECIFICATIONS

Length: 6 ft. (1.8 m)

Weight: 3.6 oz. (102 g)

Connector: 8-pin MiniDIN

MAXIMUM SPL

The maximum sound pressure level output of this instrument remains well below 90 dB SPL throughout the audible frequency range of 20 Hz to 20 kHz. This level is well within OSHA permissible limits of 90 dBA for 8 hours.

Conforms to IEC 601-1.



Appendix A

Internal Probe Specifications

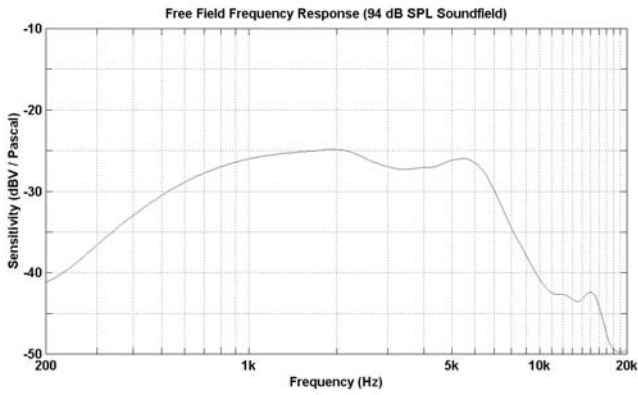

Microphone Frequency Response (Nominal)

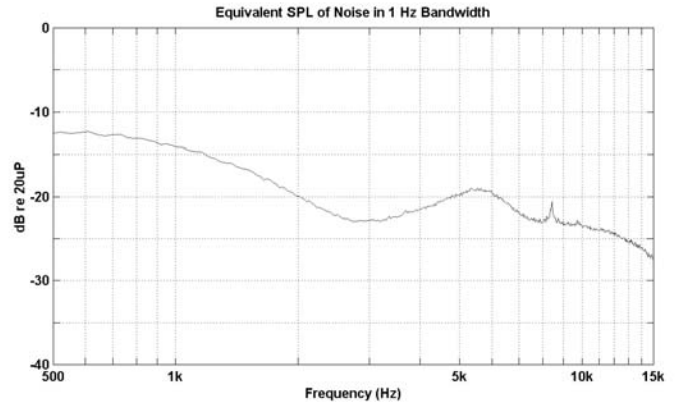

System Noise Floor (Nominal)

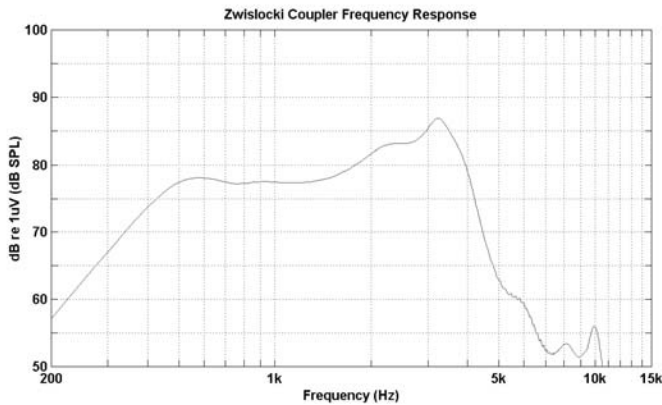

Sound Source Frequency Response (Nominal)

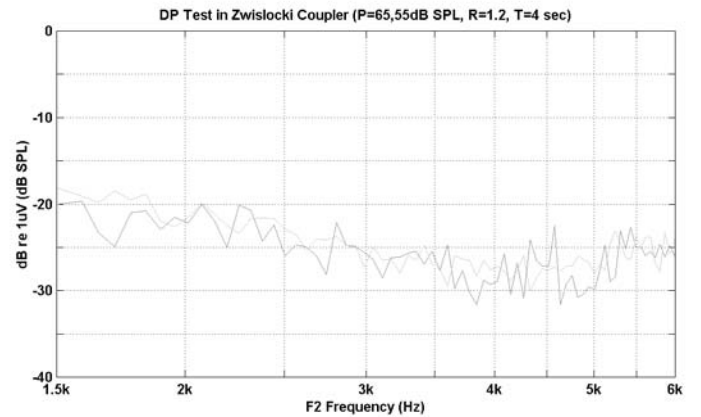

System Distortion + Noise (Nominal)



Appendix A

Remote Probe Specifications

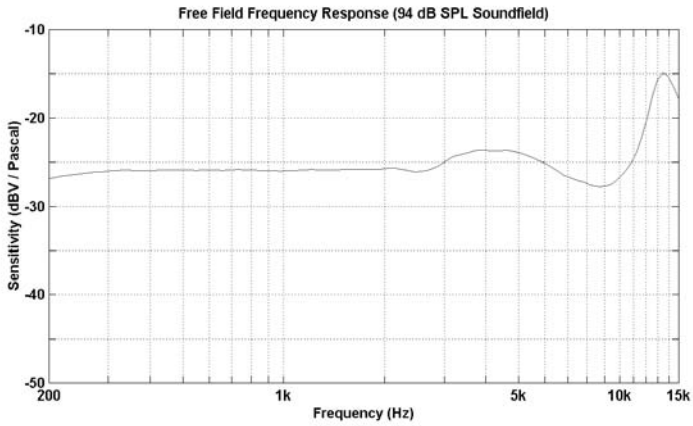

Microphone Frequency Response (Nominal)

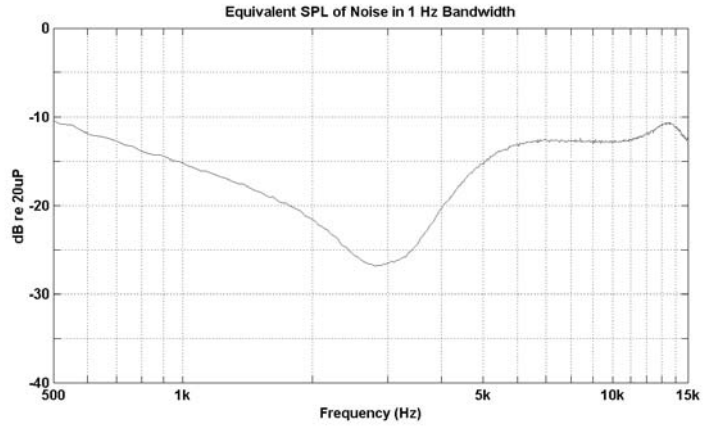

System Noise Floor (Nominal)

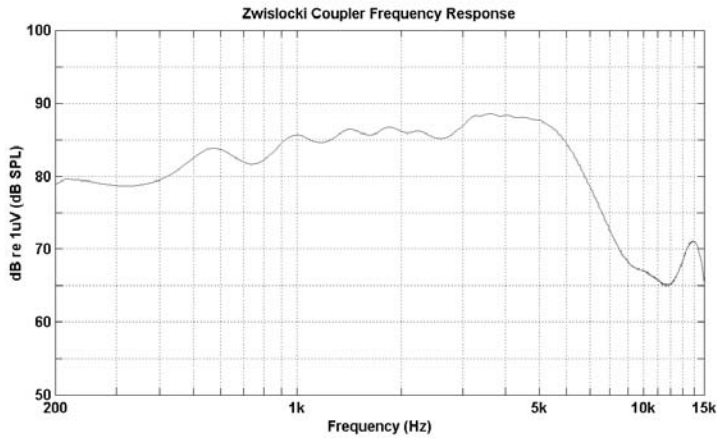

Sound Source Frequency Response (Nominal)

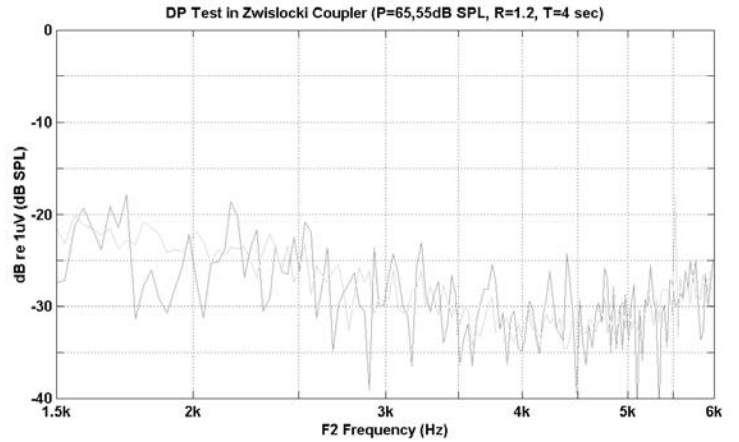

System Distortion + Noise (Nominal)

Appendix B

Program Flowchart

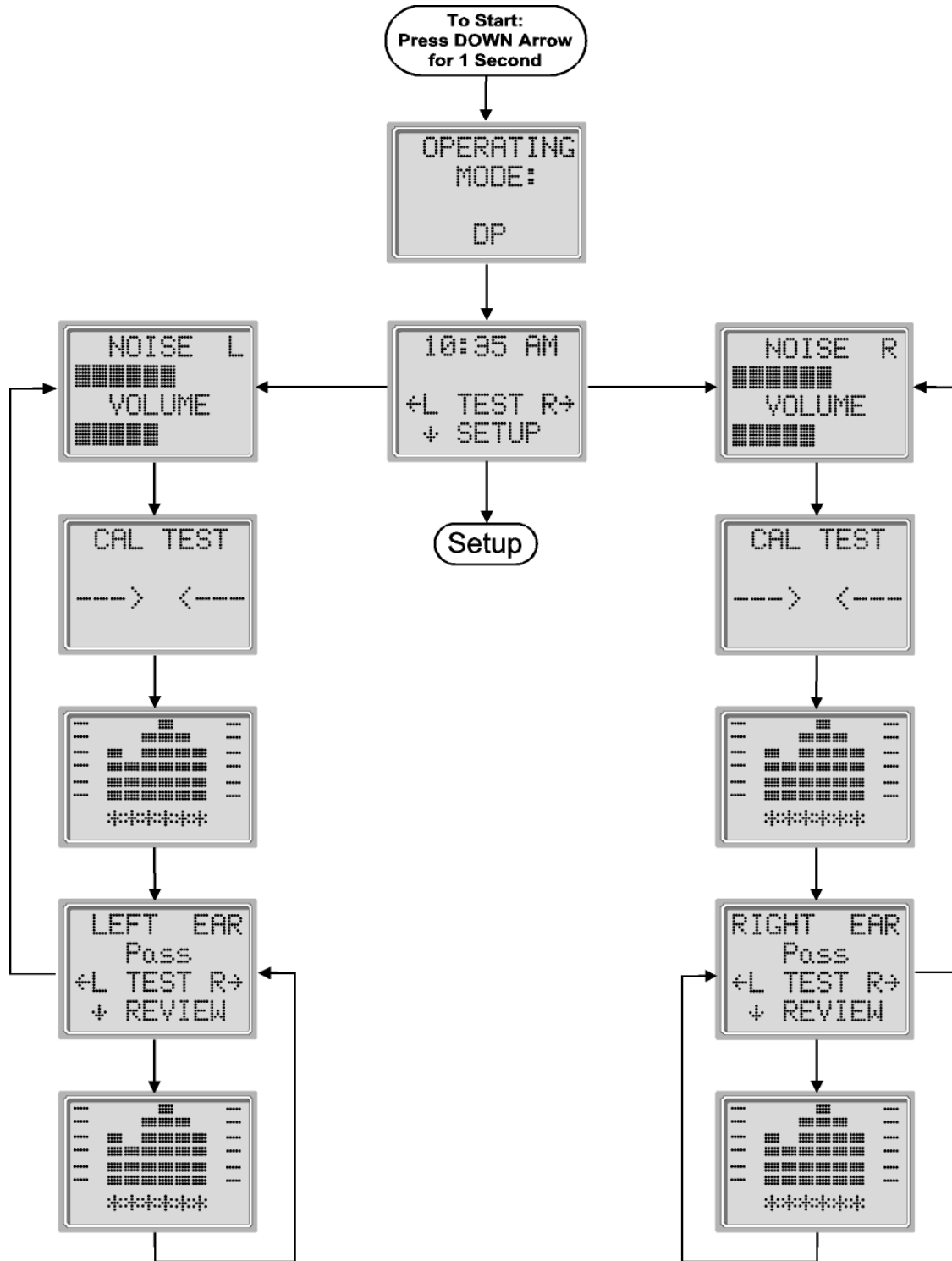

Appendix B

Program Flowchart

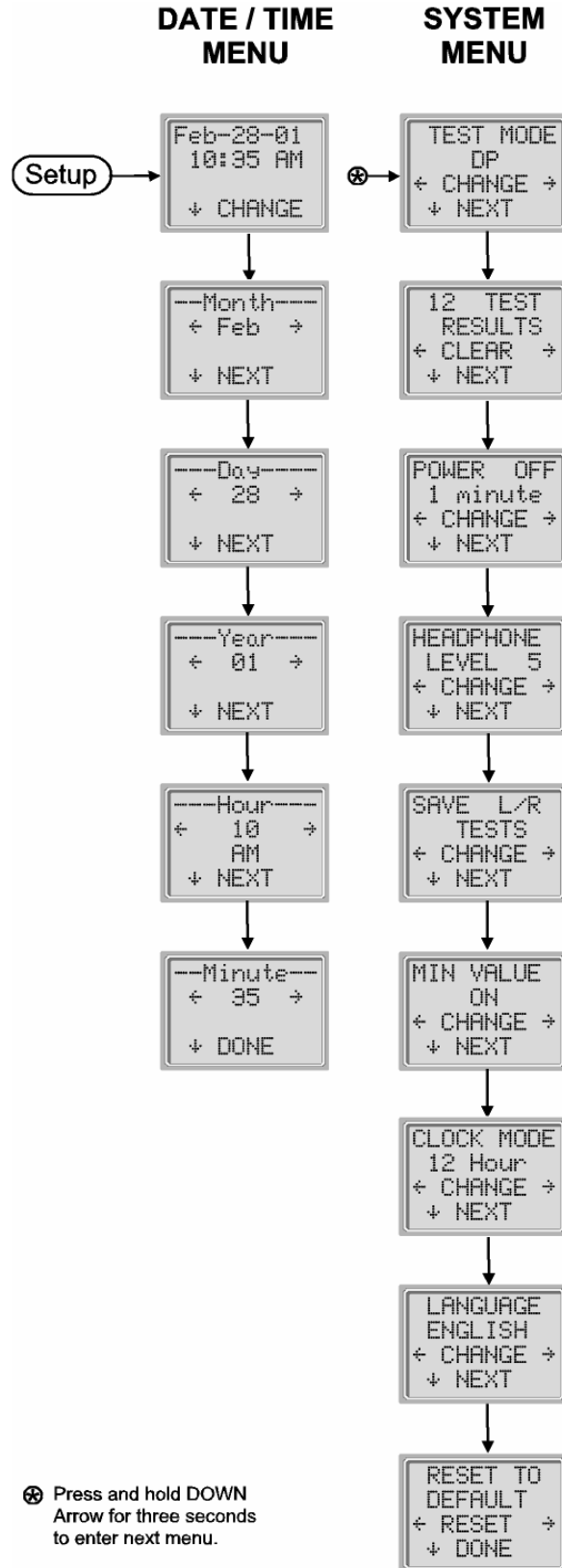



Appendix C

Test Sequence

A complete test sequence consists of an **autostart**, **calibration** and **test phase**. The **autostart phase** determines when the **calibration phase** should proceed, while the calibration phase calibrates the level of the tones that will be applied during the actual **test phase**. Artifact rejection is employed during the **test phase** to reduce the effect of transient noise bursts.

Immediately after the test button is pressed, the **autostart phase** of the test begins. **Autostart** checks both the quality and stability of the seal by measuring the response obtained from a sequence of test tones. The stability of the seal is determined by comparing the responses obtained over time. When the level of the response is within an acceptable range and is stable over time, the unit proceeds to the **calibration phase**.

FOR DPOAE

The **calibration phase** automatically measures the response obtained from a sequence of calibration tones and calculates the voltage needed to obtain the desired pressures. If one or more of the desired pressures cannot be obtained, the instrument terminates operation and displays an error message. A successful calibration leads to the actual test phase.

The **test phase** consists of measuring the response obtained from the pairs of test frequencies (f_1 , f_2) applied to the receivers. Two receivers are used, with each receiver generating one frequency in order to reduce intermodulation distortion. Frequency domain estimates of the actual P1, P2, distortion (DP) and noise floor (NF) are obtained via the discrete Fourier Transform, with a bin resolution of approximately 31 Hz. The NF estimate is obtained by averaging the power in the 4 closest (+/-2) bins to the DP bin.

FOR TEOAE

The **calibration phase** automatically measures the peak pressure obtained from a sequence of clicks and calculates the voltage required to obtain the target peak pressure. If the desired peak pressure cannot be obtained, the unit will use the maximum voltage.

The test phase consists of measuring the response obtained from repeated sequences of clicks applied to the receivers. The click sequence is 3-1-1-1 repeated twice. Signal and noise floor estimates are obtained by adding/subtracting the two response sequences respectively. The energy of the signal and noise floor estimates in various frequency bands is obtained in real time and displayed once per second. The average peak pressure of the stimulus is calculated after completion of the test.

Artifact rejection is employed during the **test phase** to reduce the effect of transient noise bursts by the use of an adaptive rejection threshold. The unit attempts to accept the quieter sections of the test, while rejecting the noisier portions of the test. When the noise level is approximately constant during the test, the instrument will tend to accept most of the data in the test. However, as the level of the noise becomes more variable over time, the instrument will attempt to accept the quieter portions of the recording. Noise estimates are obtained approximately 32 times per second and a suitable threshold is estimated from the data. Data segments with a noise floor above this threshold are rejected, which tends to lower the noise floor of the test. In order to reduce the possibility of obtaining an artificially low noise floor, the minimum threshold level is limited.

Comment About Variations in the SNR Estimate

The user needs to be aware that the SNR estimate has an inherent statistical variation due to the effects of random noise, especially when no emission is actually present. If a test is performed with the instrument's probe placed in a test cavity, it can be shown theoretically that the SNR will be greater than 6 dB approximately 7 times out of 100. This is not a limitation of the instrument, but a fundamental property of the method used to estimate the SNR in all emission testing. In order to reduce the occurrence of this "false" emission, the instrument limits the minimum value of NF, which has the effect of reducing the SNR for tests that have a low noise floor. As the noise level of the test increases, the user will notice that more "false" emissions will appear, which is to be expected.



Appendix D

Pass/Refer Criteria for DPOAE

The decision that a DPOAE exists is based on detecting a signal whose level is significantly above the background noise level. This requires a statistical decision, since the random noise level in the DPOAE filter channel can be expected to exceed the average of the random noise levels in the four adjacent filter channels — used as the reference for comparison — roughly half the time.

Extended measurements of the noise distributions in both the DPOAE filter channel “DP level” and the rms average of the 4 adjacent channels “N level” indicate that the signal-to-noise ratio (the difference between DP and N) has a standard deviation of 5.5 dB. As shown in the figure below, this implies a 10% probability of seeing a 7 dB SNR simply from the variability of the noise levels in the 2 filter sets.

Requiring an SNR of 6 dB in three out of four frequencies drops the probability of passing an ear with significant hearing loss to 1% or less. Note: By the binomial distribution, two of three frequencies at >8.4 dB or three of six frequencies at >7 dB should also ensure less than 1% probability of passing a moderately-severe hearing-impaired infant.

Preliminary ERO•SCAN trials with newborns indicate that the tester’s technique is the single most important variable in the pass rate on normal-hearing infants. Some testers pick up the technique (see *Operating Instructions* section, page 10) with only a couple of days’ practice, producing pass rates comparable to those for other DPOAE equipment they have used for months; other testers take longer.

Note: The easiest way to obtain a PASS is to a) make sure the eartip is fully seated on the probe tip and b) make sure the eartip is as deeply seated in the ear canal as possible. (See Appendix F.)

Occasional claims of extraordinarily low probabilities of missing an ear with hearing loss appear to be based on poor statistics. As discussed by Gorga (Mayo Clinic Teleconference, 1998), since the incidence of significant hearing loss is roughly 2 per 1000, verifying a 99.7% accuracy would require testing hundreds of thousands of babies with a given system. Thus to demonstrate that only 3 babies out of 1000 with hearing loss were missed would require follow-up testing on 500,000 babies. To our knowledge, no one has performed such tests to date.

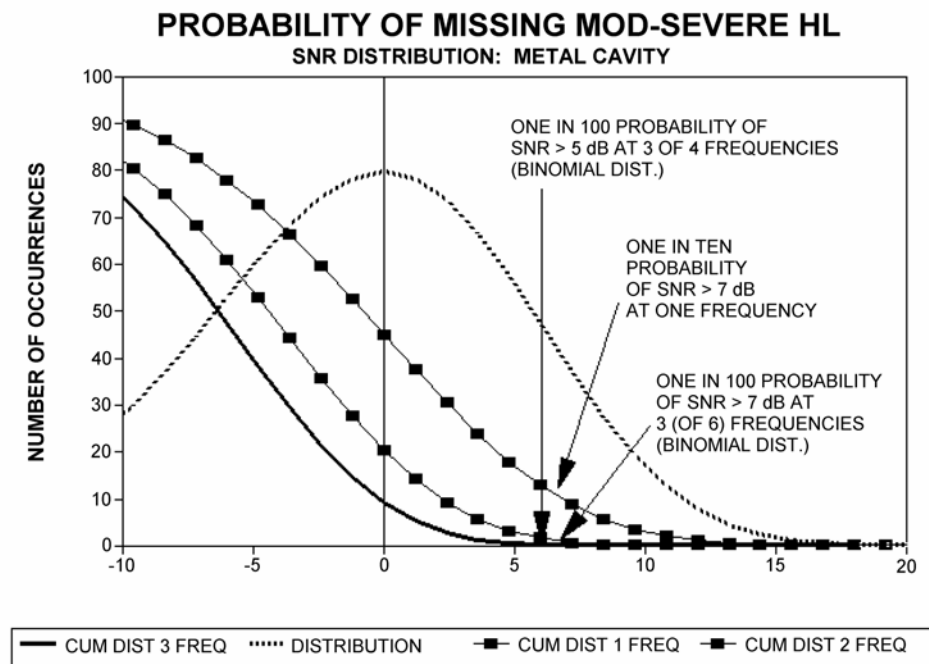

ESCRIT2.WQ1



Appendix D

Pass/Refer Criteria for TEOAE

The same basic principles that underlie DPOAE Pass/Fail criteria underlie TEOAE Pass/Fail criteria. In the case of transients, requiring SNR of 4 dB at any three out of the six test frequencies drops the probability of passing an ear with a significant hearing loss to less than 1%.

Note: The SNR limits for transients are lower than the corresponding limits for distortion products primarily because the traditional noise calculation used in TEOAE measurements (and in the ERO•SCAN instrument) gives a 3 dB lower SNR than the calculation used for DPOAEs. Without that difference, the numerical SNR value for a PASS with the two methods would be quite similar.

The ERO•SCAN uses a novel noise-rejection algorithm (patent pending) that permits accurate DPOAE and TEOAE measurements in background noise and babble as high as 55-65 dB SPL (A-weighted). Briefly explained, use of available memory in the ERO•SCAN processor permits a post-hoc statistical analysis that identifies those samples whose retention would improve the overall accuracy. Those samples are included in the final analysis; the noisier samples are rejected.

The improved operation in noise with the new algorithm was so substantial that we conducted a complete replica of our original validation tests in "fully impaired ear" cavities and were able to verify that no increase in false negatives (false passes) was introduced. Under no test conditions was any such degradation uncovered.

The artifact rejection can only reject the noisiest samples in a measurement period. If the ambient noise level rises too high (and/or the eartip seal is poor), then all samples will be noisy and accurate measurements will be impossible, in which case the test result will indicate "noisy."

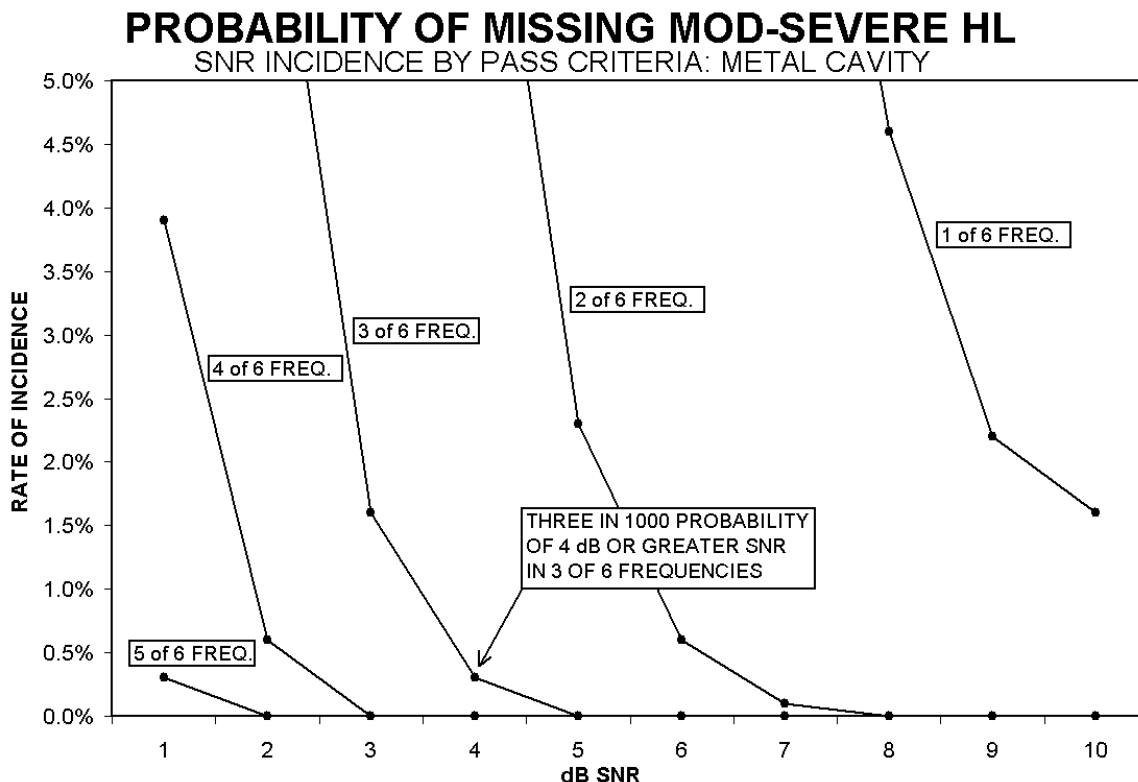



Appendix E

Preset Test Protocols

DP

Number of Frequencies Tested = 4
Frequency Range = 2 kHz to 5 kHz
P1 (Intensity of F1 in dB SPL) = 65
P2 (Intensity of F2 in dB SPL) = 55
Averaging Time = 4 seconds per frequency
Pass SNR (Signal-to-Noise Ratio) = 6 dB
Number of Passing Frequencies for Overall Test Pass = 3

DP CUSTOM

Number of Frequencies Tested = 4
Frequency Range = 2 kHz to 5 kHz
P1 (Intensity of F1 in dB SPL) = 65
P2 (Intensity of F2 in dB SPL) = 55
Averaging Time = 2 seconds
Pass SNR (Signal-to-Noise Ratio) = 6 dB
Number of Passing Frequencies for Overall Test Pass = 3

TE

Number of Frequencies Tested = 6
Frequency Range = 1.5 kHz to 4 kHz
Averaging Time = 64 seconds
Pass SNR (Signal-to-Noise Ratio) = 4 dB
Number of Passing Frequencies for Overall Test Pass = 3

Appendix F

Testing at 4 kHz

Emission levels at 4 kHz are usually stronger than those at 2 and 3 kHz, so 4 kHz should be the easiest frequency at which to obtain a PASS result. Two things can reverse the score: a) a shallow eartip placement in the ear, and b) an eartip that is not fully seated on the probe tip.

Figure 1 illustrates measurements made on newborns at Childrens National Medical Center, Washington, D.C. several years ago (courtesy of Gil Herer). The signal-to-noise ratio at 4 kHz is better than at lower frequencies for the best testers, but the new trainees had trouble obtaining a pass.

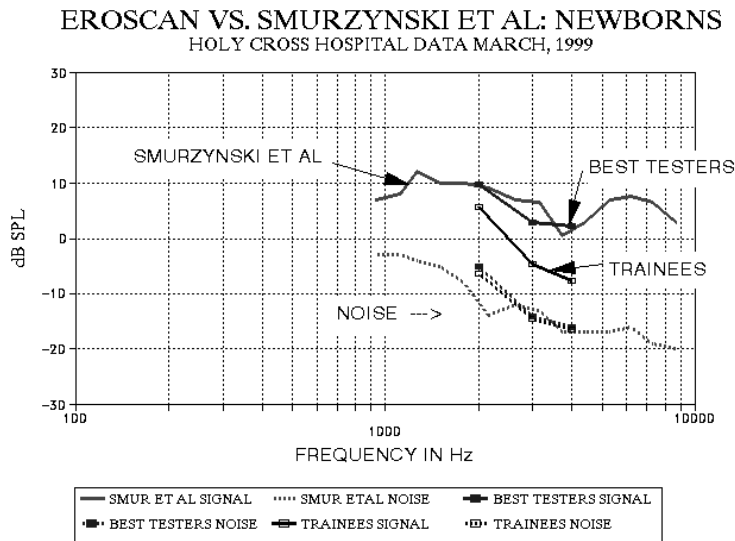

Probe microphone data show that an eartip improperly seated on the probe tip can reduce the f1 and f2 signal SPLs at the eardrum by 10-12 dB, producing perhaps a 5-dB reduction in the DP level (Figure 2). Similarly, a shallow placement of the eartip in the ear canal reduces both the f1 and f2 level, and directly reduces the measured SPL of the distortion product.

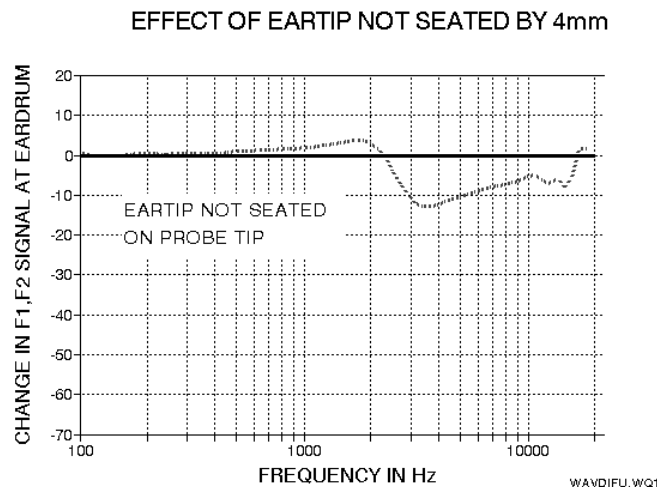

With practice, most testers learn to fully seat the eartip on the probe tip and to obtain a deep seal in the ear under test.

